

FUELCO LTKD5

Fuel Tank



Product Name	KUBE LTKD5
Manufacturer	Fuelco
Category	Diesel Fuel Tank

TECHNICAL SPECIFICATIONS

Tank Specifications	
Tank Capacity (L)	4460 L
Safe Fill (L)	4240 L
Shape	Rectangular
Tank Body Material	Self-bunded carbon steel
Lifting Points	Included for crane handling
Channel Support	2 x suitable channels
Compartments	Single compartment
Manhole	Secure manway for cleaning and inspections
Wall Type	Double wall
Extras	
Fork Pockets	Double-sided access
Baffled Internally	To restrict product movement
Galvanized Edge	Prevents nicks and damage

FUELCO LTKD5

Fuel Tank



WEIGHTS & DIMENSIONS

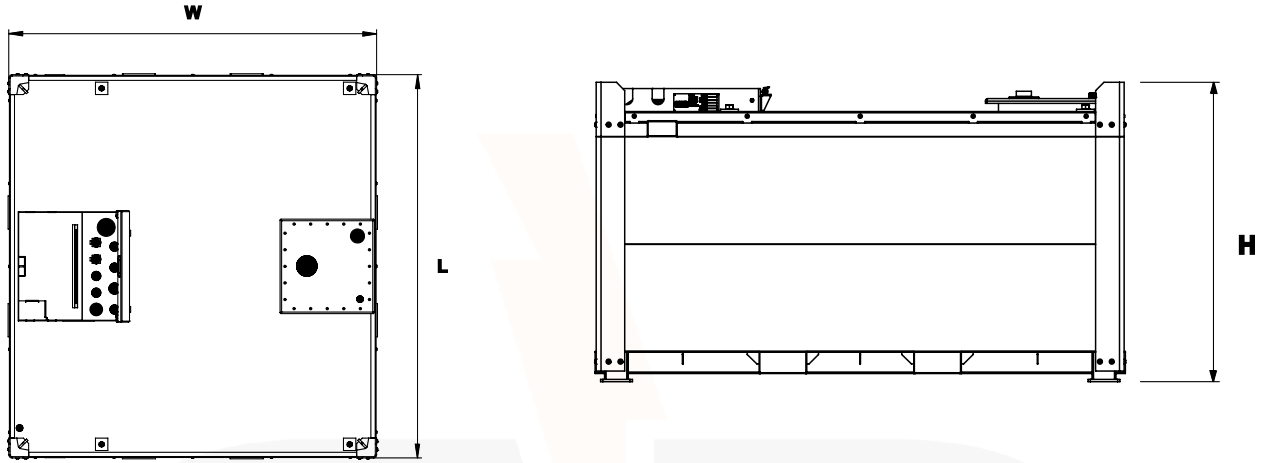

Length (L) mm	Width (W) mm	Height (H)mm
2230 mm	2312 mm	1274 mm

Dry Weight (kg)	
Dry Weight	1155 kg

www.rentalgp.com

©2024 Glow Power Equipment Rental LLC

All rights reserved.

This publication is based on datasheets from respective manufacturers and is intended for informational purposes only. All trademarks and proprietary materials belong to their owners. Glow Power holds no rights to the technical data presented and does not intend to infringe upon copyrights or trademarks.